

Construction

100+ complex syntax

two-page opening



Materials

It is recommended that PODD books constructed for **direct pointing access are laminated using 80micron laminate**. Waterproof paper and thinner laminated pages are not recommended for anyone who slides their hand across or pushes onto the page when pointing as the pages move or scrunch up making it very difficult to read the point and eventually become damaged. Communication may also break down for individuals with additional sensory processing challenges if they “fiddle with”, flick or scrunch pages to seek additional sensory input. Thinner laminate or waterproof paper is only recommended for direct access when the individual has a very light point (hand direct touch on and lift off the item), and no additional sensory processing challenges.

DO NOT USE laminate thicker than 80 microns for any PODD communication book. PODD books have many pages to laminate and they can become heavy and unwieldy if thicker laminate is used. Even a few extra microns on each page can significantly add to the weight and thickness of the whole communication book. **Matt finish laminate** is recommended to reduce glare on communication book pages.

This two-page opening style PODD communication book works best when the pages do not fold back over the spine of the book when the book is held open. **Comb binding is recommended** to provide a more stable page opening when the book is held in one hand by the partner or rested on the lap for direct pointing access. **DO NOT put the pages in a ring binder or bind with rings, cable ties or spiral coils** (see information on binding).

Materials & Equipment List

- iPad with simPODD
- Colour printer
- Laminator
- (Computer – recommended)
- Comb binding machine and one 38mm binding comb
- Scissors
- Ruler
- Glue stick
- Cloth duct tape
- A4 plain paper
- A4 Label stickers - printer labels with one label per sheet (approximately 12-15 sheets*)
- Matt 80 micron laminating pouches (approximately 82 pouches*) OR Matt 80 micron laminate roll
- 2 clear plastic letter files

* The precise number of pages will vary depending on individual customisation.

To make a plastic covered book

- Two pieces of plastic, 22.5cm x 23cm (e.g., covers of sheet protector presentation books)
- Approximately 90cm of hook and loop sticky back Velcro®.

To make a cardboard covered book

- Two pieces of thick cardboard, 22.5cm x 23cm

TIPS for Printing

There are two options for printing your PODD book.

- Exporting the pages from simPODD to a PDF file to print from your computer.
- Printing pages directly from simPODD on your iPad with a Wi-Fi enabled printer.

Printing the PODD book from your computer is the recommended option as it provides more control over the print settings.

- The pages occasionally print at unusual sizes directly from the iPad.
- It is easier to view and select pages for printing in the PDF on your computer.
- Exporting to the computer also creates a backup PDF of your personalized PODD book.

Scaled printing is not recommended for this book.

Remove blank list squares before printing

Lists are printed onto stickers so that they can be easily written on with any pen/pencil. It can be difficult to accurately line up the sticker lists over an existing grid. Therefore, it is recommended to hide the borders on blank list squares before printing. To do this:

1. In edit mode, select *Edit Multiple*.
2. Select the blank list buttons (not symbol buttons or any list cells containing words).
3. Change the border colour to white.

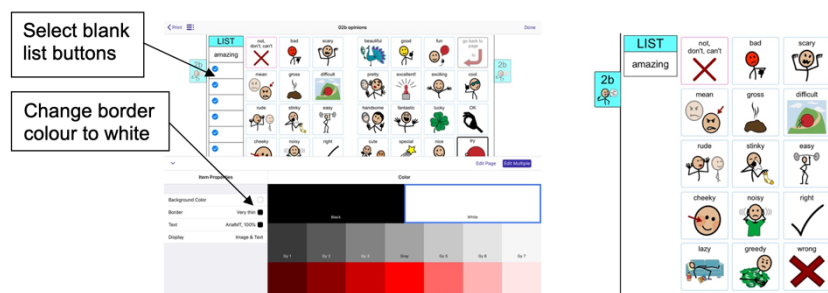

To print your PODD book from your computer:

1. Export a PDF from simPODD on your iPad to your computer
 - a. Select **Books** from the drop-down menu ☰ in the upper right corner.
 - b. Select the **three dots** on the lower right corner of the book you wish to print.
 - c. Select **Export**
 - d. Select **Mail** to email the PDF to your computer (Mac users can also use AirDrop).
2. On your computer open the PDF. It is easier to scroll through the pages using thumbnail images to see the print range page numbers associated with the PODD book pages. Set your software to view thumbnails.

Print Main Pages (*01 main or 01a chat to Instructions back cover*).

3. Load your printer with **A4 plain paper**.
4. Scroll through the thumbnail images to identify the PDF page number for *Instructions back cover*.
5. Select Print. The print settings are:
 - **Print pages (range): 1 to (the number you identified at step 4)**
 - Paper size: A4; Orientation: Portrait
 - Print single sided

Printing Lists A4 stickers

6. Load your printer with **A4 sticker paper**.
7. Scroll to the bottom of the list of thumbnails to identify the PDF page numbers for the first and last of the *lists* to print onto stickers.
8. Select Print. The print settings are:
 - **Print pages (range):** the number for the **first list page** to the number for **the last list page** identified at step 7.
 - Paper size: A4; Orientation: Portrait
 - Print single sided

To print directly from simPODD on your iPad:

1. Select **Books** from the drop-down menu ☰ in the upper right corner.
2. Select the **three dots** on the lower right corner of the book you wish to print.
3. Select **Export**
4. Select **Print**. The Print menu will be displayed with thumbnail images and print range numbers associated with the PODD book pages.

Print Main Pages (01 main or 01a chat to Instructions back cover).

5. Load your printer with **A4 plain paper**.
6. Scroll through the thumbnail images to identify the PDF page number for *Instructions back cover*.
7. Select Print. The print settings are:
 - **Print pages (range): 1 to (the number you identified at step 6)**
 - Paper size: A4; Orientation: Portrait
 - Print single sided (toggle double-sided to OFF)

Printing Lists A4 stickers

8. Load your printer with **A4 sticker paper** .
9. Repeat steps 1 – 4
10. Scroll to the bottom of the list of thumbnails to identify the PDF page numbers for the first and last of the *lists* to print onto stickers.
11. Select Print. The print settings are:
 - **Print pages (range):** the number for the **first list page** to the number for the **last list page** identified at step 10.
 - Paper size: A4; Orientation: Portrait
 - Print single sided (toggle double-sided to OFF)

Cutting and pasting book pages

All pages **except** the left side of *01 main*, *instructions back cover* and the optional *22b swear*

- TIP** Left side pages have tabs on the left hand side and right side pages have the tabs to the right.
- TIP** When you look at an open page, the number is the same on both the left and the right side (see picture below).
- TIP** If you become confused, open the book in simPODD to see what each page opening should look like.

- Put all the pages in order except the *left side of 01a* and *instructions back cover*. It is helpful to arrange the pages as they will be cut and pasted to make the book, e.g., *left side of 03a* turned over behind (to paste on back of) *right side of 02b*.



- Take page *01 right* (*01 main* with tab on the right hand side) and *02a left* (*02a opinions* with tab on the left hand side). Align the outside lines and tabs – you may be able to see through the paper – then glue the pages back-to-back using a glue stick.

NOTE: If you have selected to add the **optional 01b chat** pages you will need to glue *01b left* (*01b chat* with tab on the left hand side) onto the back of *01 right*. Then take *01b right* (*01b chat* with tab on the right hand side) and *02a left* (*2a opinions* with tab on the left hand side). Align the outside lines and tabs and glue them back-to-back.

- TIP** Make sure you match the tab edges of the page – not the edges of the paper when you glue. Varying printer margins change the relative position of the page on the paper causing misalignment of the front and back of a cut page.
- TIP** If you are having difficulty aligning the outside page edge lines and tabs, you may choose to cut out both pages prior to gluing. This method requires double the cutting but some people find it easier.

- Continue gluing the pages back-to-back, checking that the tabs line up, until all of the pages are glued together.
- When all the pages have been glued together, cut along the black line around the tab on each page. (See diagram below)

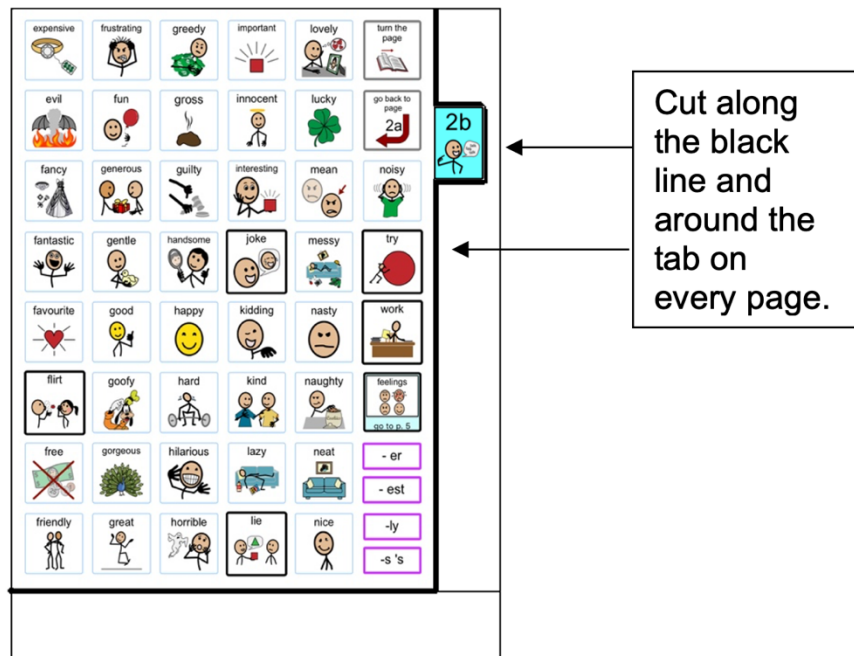

Depending on your printer margins there may be a small hangover of one or the other pages on the edge opposite the page tab. As this edge will be bound it usually does not alter either the appearance or functionality of the communication book. You may choose to trim this page edge.

Laminate the pages

Important information about laminate thickness

PODD communication books have many pages to laminate. Even a few extra microns on each page can significantly add to the weight and thickness of the whole communication book.

DO NOT USE laminate thicker than 80 microns.

1. Laminate all of the cut-out pages, up to *23b alphabet* (with *24a topic* on the back).
Do not laminate the right side of *24a topic* and *24b topic* as these will be placed in heavy duty clear plastic sleeves.
2. Cut out each page leaving a 3-5mm border of sealed laminate around the edge of each page. Round off the corners.

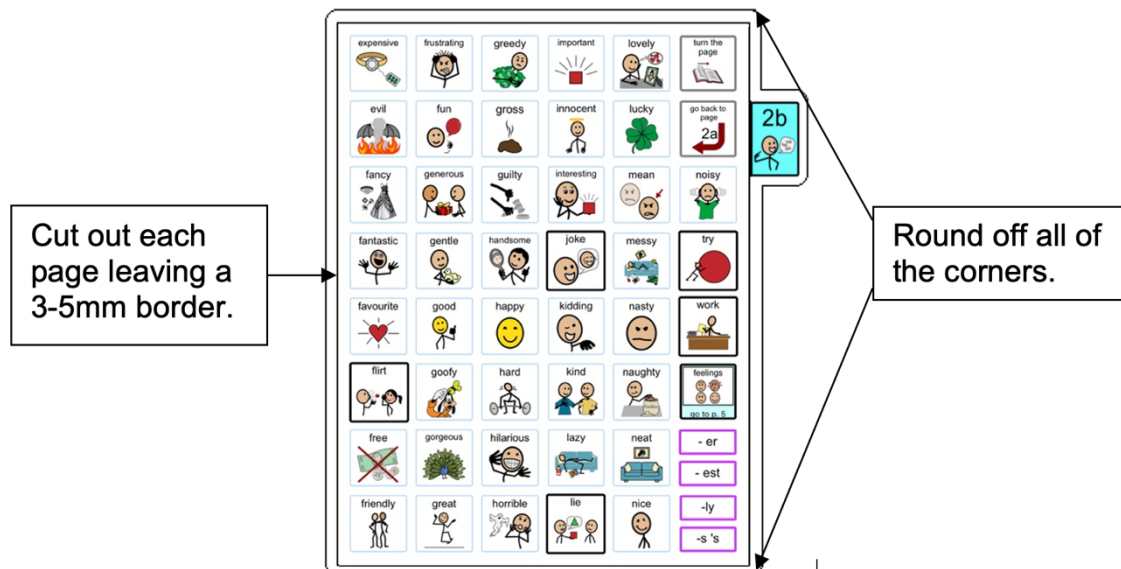

If you are going use plastic cover (see information below)

Cut out and laminate the pages *left side of 01 main/01a chat* and *Instructions for back cover*. Trim around the laminate leaving a 5mm border of sealed laminate around the edge.

If you are going use cardboard cover you will laminate these pages after you glue them onto the cardboard cover (see information below)

If you are going use the optional 22b with swear pages, cut out and laminate the cover for swear words sticker (*list 07 22b with swear cover*). Remember to make sure the sticker includes all the pictures you have selected to represent swear words on the cover (the text is on the page underneath the cover so that it cannot be viewed until the user instructs their partner to lift the flap).

Adding the lists

You should have 13 pages of lists printed onto A4 stickers, labelled with their page numbers.

TIP Most stickers have an edge from which it is easiest to peel the backing. Try to leave this edge intact when you cut out the list.

TIP Do not cut on the lines of each list, cut very close to the edge but leave the lines intact.

1. Leaf through the book until you find a page which has had its lists deleted. The first page should be *02b opinions left*. (See below)

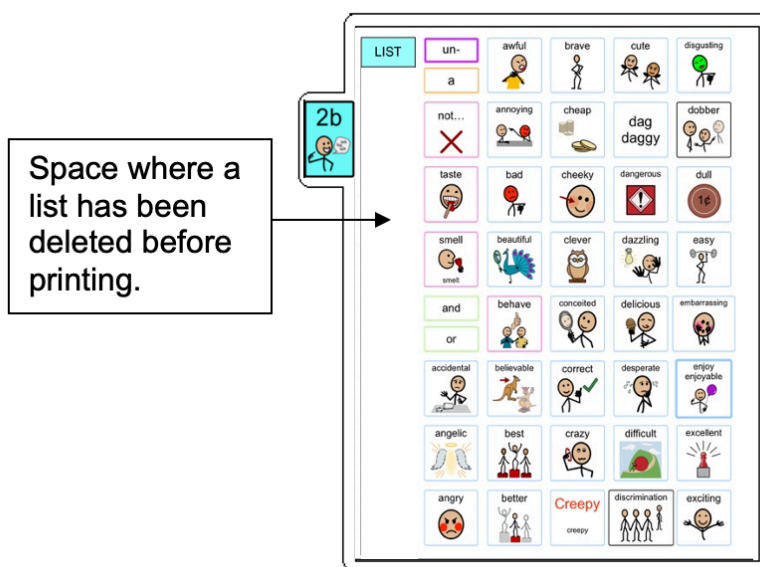

2. Locate the list labelled 2b on the sticker. Cut it out leaving its edges intact and any part of the sticker that will make the list easier to peel off the backing sheet.

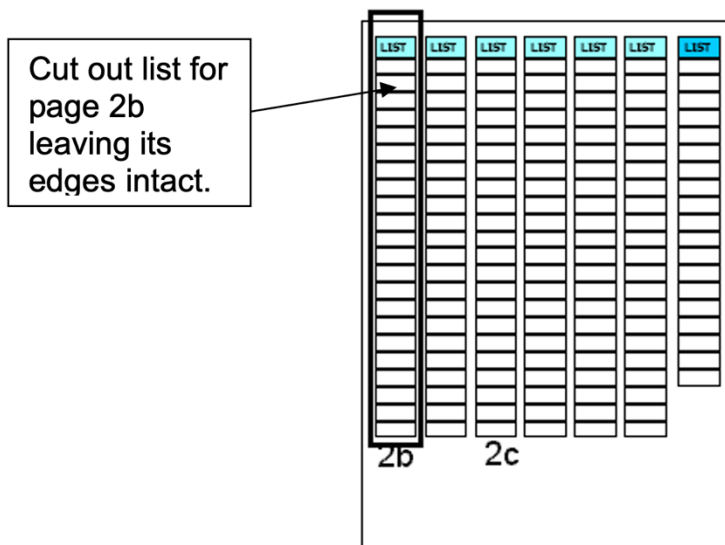

3. Peel off the back of the list and cut off any excess sticker. Stick it on to the laminated page. If you are unsure about where to stick the list, open the corresponding template page in simPODD to see what it should look like.

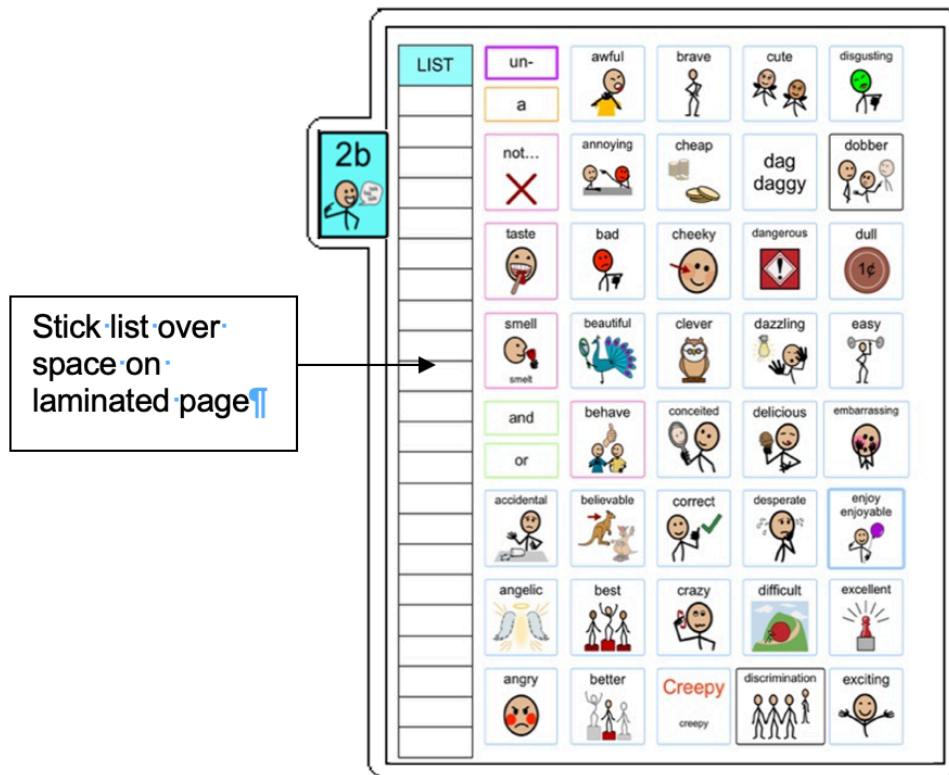

TIP Do not cover any list cells that already have words in them.

4. Leaf through the book until you find the next page with its list deleted, cut and add the appropriate sticker. Repeat the process until you get to page 7b.
5. 7b - 7k actions. Measure or estimate how many cells it will take to fill each gap on the action pages. Cut out a block of cells to fill the gap, peel off the back and stick the block of cells in the gap on the page. It may be easier to cut off strips of cells, peel off the back and then cut them to size. Continue until all the gaps in the actions section are filled. If you are unsure about where to stick the list open the corresponding template page in simPODD to see what it should look like.
6. Continue finding the spaces for lists and adding list stickers until you have added stickers to all list spaces in the communication book.

Special Pages

There are 2 types of special pages that may be used in this PODD book.

1. The topic pages *24a* and *24b* are not laminated but slide into clear plastic pockets (letter files) so that they can be easily removed and filled in by hand.
2. The optional *22b little words / swear page*. This page has discretionary flaps to cover the swear words.

Making the topic pages

You can add as many pages as you like for different topics. The instructions here are for one topic only.

You will need:

- Pages *24a topic right* and *24b topic left and right* pages.
- 2 clear A4 letter files (available from office supply stores)
- Scissors
- Ruler

1. Cut out a rectangle measuring 23cm height x 20.5cm width, leaving the bottom of the letter file sealed and one vertical side sealed. (See below)

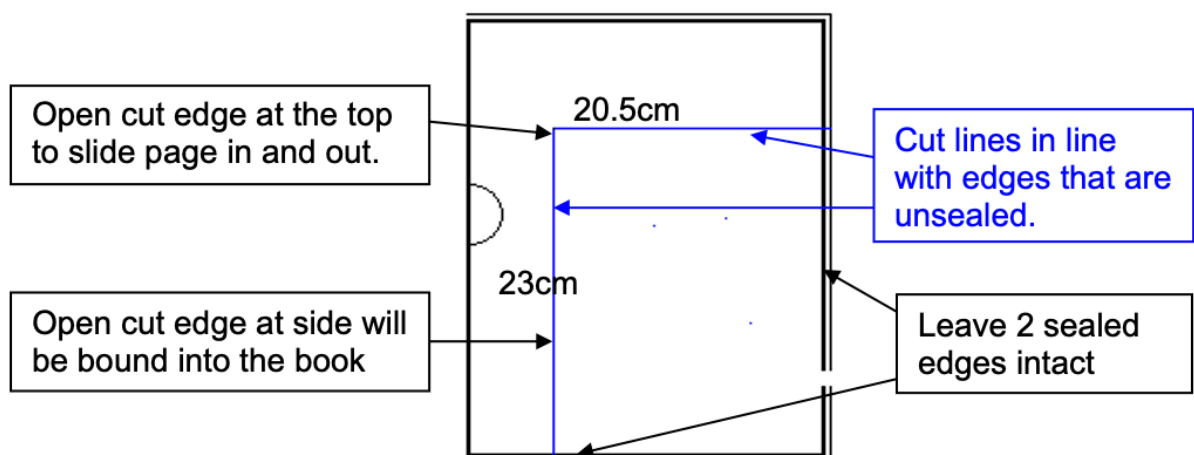

- Place the topic page in the letter file with the tabs against the vertical sealed edge. The open side is the binding edge. The opening at the top allows the pages to slide in and out.

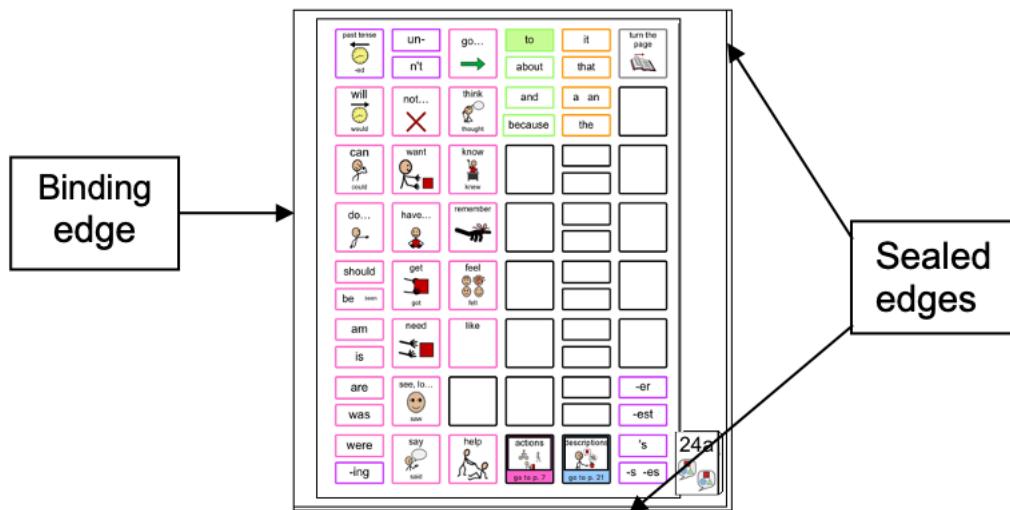

TIP Remove the page from inside the letter file when binding, so that the page can't get caught in the binding. Bind only the letter file.

(Optional) Making the swear page

You will need:

- Pages *flap backers*, *cover for swear words*, *22b left (option for swear)*
- Scissors and blade knife (Stanley knife)

- Cut out the squares on the page labelled *flap backers* and put to one side.
- Take the laminated sticker *cover for swear words*. Using a blade, cut down the sides and along the bottom of each swear word cell as marked in red on the diagram below.

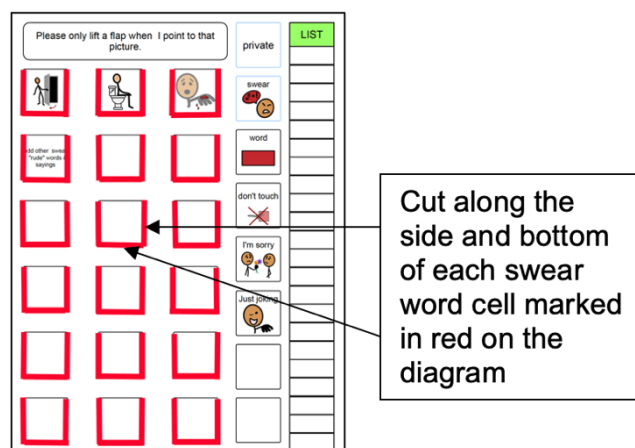

- Place the cut out cover for swear words page face down on the table. Carefully peel off the back of the sticker.
- Stick the flap backer squares to the back of each flap (cell). The purpose of this is to stop the flap sticking down when it is stuck on top of page 22b.

Back of cover for swear words.

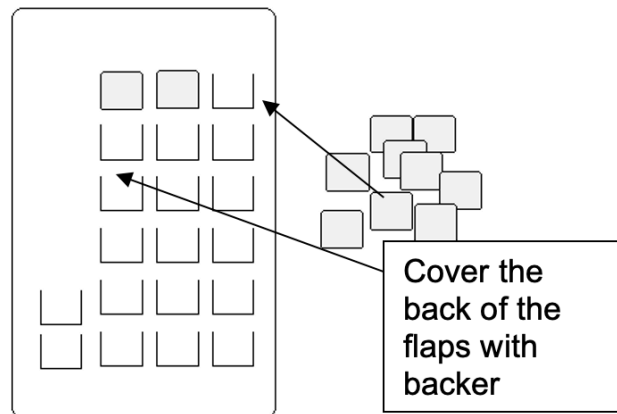

- Take the prepared cover sticker and position it on top of page 22b left so that the flaps fit over the matching cells below. Stick the cover down onto the page 22b left.
- Flip open each cell. You may need to use the blade to do this.
- On the completed swear page, the flaps should lift up to reveal the written swear word below.

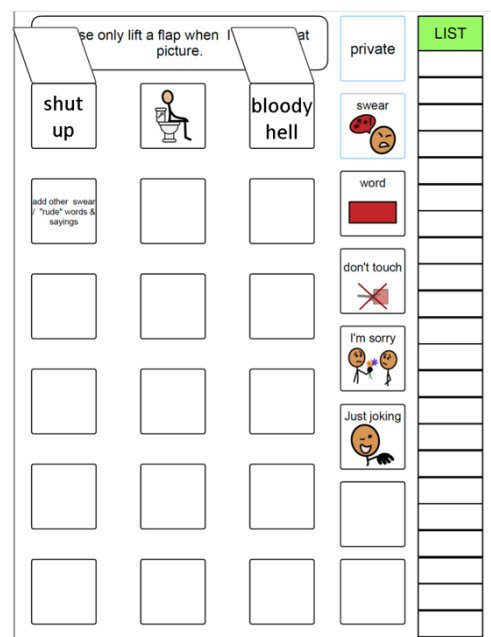

Making the covers

Instructions are included to use either a plastic or a cardboard cover.

Instructions for creating a plastic cover

1. Measure and cut 2 rectangles 22.5cm x 23cm out of the thick plastic to make the covers. Round off any sharp corners.
2. Cut out the laminated printed stickers, for pages for the *left side of 01 main / 01a chat* and *instructions back cover*.
3. Attach the laminated pages to the covers of the book. To do this:
 - A. Join a strip of hook and loop Velcro®. Cut the strip along the middle into two long narrow strips.

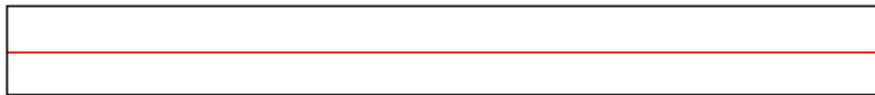

- B. Measure and cut these halved strips to fit along all edges of both covers, i.e., four strips for each cover. You will need four strips approximately 24cm long and four strips approximately 21cm long (see diagram below).
- C. Remove the paper from the loop (soft) side of the Velcro® and attach it to the cover as seen in the diagram below.

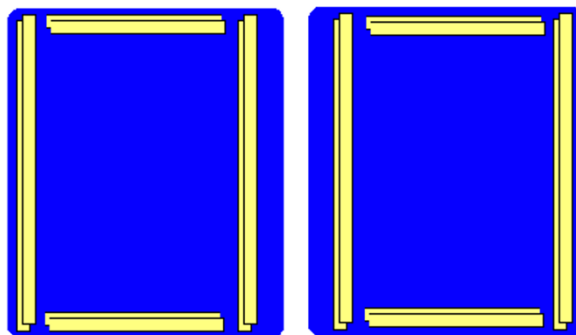

- D. When all four pieces are in place on each cover, remove the paper backing from the hook (rough) side (now facing out from the cover) and position the *left side of 01* on the inside of front cover and *Instructions back cover* on the inside of the back cover.



Inside front cover



Inside back cover

- E. Press down along edges to get a strong attachment.

Instructions to make a cardboard cover

1. Measure and cut two rectangles sized 22.5cm x 23 cm out of thick cardboard to make the covers. Round off any sharp corners.
2. Cut out the left side of *01a main* and glue it to the front inside cover. Position the page centrally on the cover allowing space for binding and taping of edges.
3. Cut out the *Instructions back cover* and glue it to the back inside cover. Position the page centrally on the cover allowing space for binding and taping of edges.



Inside front cover



Inside back cover

4. You may wish to personalise the book by decorating the front cover with pictures or the individual's name written in a fancy font.
5. Set your laminator to a hot setting and laminate both cardboard covers. Trim around each cover leaving a 5mm border of laminate on every side.
6. Use cloth binding tape to reinforce the edges shown by the dark line in diagram below. To do this:
 - A. Cut a length of tape to suit length of the side you are reinforcing
 - B. Position the tape very close to the printed cells and stick down. Ensure you do not cover the printed text.
 - C. Fold the remaining tape over the edge of the cover and stick down on the other side.



Binding

Comb binding is recommended for this style of PODD book.

Comb binding does not allow pages to bend back over the spine of the book. This creates a more stable surface for pointing when the book is held by the partner or rested on a lap. It also allows for easier movement for the communicator to point across the two pages on an opening without catching their hand on a binding or needing to lift their hand up off the surface to clear a binding in the centre of the page opening. Comb bindings do deteriorate with heavy use; however, they are relatively easy to replace by schools and families (many schools have comb binding machines). Having to do routine maintenance is more desirable than selecting a binding that breaks down communication interactions on a daily basis.

DO NOT put the pages in a ring binder, bind with rings, cable ties or spiral coils.

A ring binder results in a wider book with the pages separated in the middle to the width of the spine of the binder. The laminated pages also tend to catch in the rings, causing the rings to open and pages to fall out.

Binding with rings, cable ties or spiral coils results in a book that folds back over the spine of the book when it is held open. This is not desirable in a two-page opening PODD book.

Comb binding

Before binding check your pages are in order. If using the optional school topic pages, add two **empty** plastic sleeves to the end of the book before binding (avoids the replaceable paper topic pages becoming caught in the binding).

Bind the PODD book pages according to your binding machine's instructions.

To make the comb binding more durable and stable, lock the binding and pull alternate teeth to the outside of the spine (i.e., one in and one out) and tape to the comb. Tuck excess tape around the ends of the binding comb.

